



V A L C A N

The Defining Standard

A1 RATED ALUMINIUM CLADDING

Valcan VitraDual®



vitradual

Aluminium Cladding Panel

bsi.identify



Registered manufacturer 2023/24

CCPI

ASSESSED PRODUCT INFORMATION
003100070/0626

VitraDual 5754 Grade
products







OUR VISION

To lead the industry as an innovative and proactive organisation, consistently delivering non-combustible façade solutions, renowned for excellence of product, product support and superior customer service – **the defining standard**.



OUR MISSION

To be the market leader in non-combustible façades for high-rise buildings, through design and supply of A1 and A2 rated rainscreen cladding systems, that are easy to buy and fast to install.



OUR VALUES

Our commitment to **respect, loyalty, honesty, innovation, responsiveness, and teamwork** means that we deliver exceptional products & services that exceed customer expectations, build strong and lasting relationships with our customers and partners, and continuously strive to improve and innovate to better serve our customers' evolving needs.

CONTENTS

About Valcan	4 - 5
What is VitraDual?	6
Production Process	7
Quality	8
Testing and Specifications	9 - 12
Thermal Performance	13
Colours & Finishes	14 - 17
Material Properties	18 - 21
Fixing options	22 - 33
Fabrication Methods	34 - 35
Storage and Maintenance	36 - 37
VitraDual Projects	38 - 39
Sustainability at Valcan	40 - 41
CPDs, Support and Toolbox Talks	42 - 43

All information (including any drawings, designs or specified materials) set out in this document is provided for guidance only. We do not accept any liability for it and do not warrant or take responsibility for its accuracy.

The document does not take into account the requirements of your project and should not be relied upon. All information contained in it should be verified and approved by a qualified professional to ensure it meets your requirements and the requirements of your project.

The information and prices contained here are believed to be correct at time of publishing. Valcan reserves the right to revise the contents of this document at any time.

VALCAN, YOUR TRUSTED PARTNER IN A1/A2 NON-COMBUSTIBLE CLADDING SOLUTIONS



WHO WE ARE

Valcan is the trading name of Fairview Europe Ltd and we are part of the Fairview global family. Valcan is a developer and manufacturer of rainscreen cladding systems working with clients, insurers, architects and contractors.

We deliver fully tested non combustible A1 /A2 (A2-s1,d0) certified solutions, paired with reliable and technically assured customer service.

With over 20 years of experience in the façade industry through Fairview's global network, we have established a leading position in the market and are now the preferred company by Architects, Contractors and Fabricators.

HISTORY

Valcan initiated its distribution of Vitrabond A2 Aluminium Composite material to the construction industry during the early 2000s. This effort was made possible through the unwavering support of Fairview Architectural, Australia – a partnership that remains robust to this day.

With a solid background in the façade industry spanning over two decades, Fairview Architectural initially catered to the rainscreen market with their flagship product, Vitrabond – since superseded by VitraDual.

Presently, we offer a diverse range of 10 products, along with a range of complete cladding systems. Our commitment to providing exceptional customer service drives us to continuously improve our processes and offerings.

WHY CHOOSE VALCAN?

At Valcan, we do not design or install products ourselves. Instead, we have a network of trusted partners we collaborate with to ensure your project is completed to the highest standards of quality and safety. These partners, selected for their expertise, knowledge, and ability to deliver outstanding results, include designers, fabricators, and distributors sharing our commitment to quality, safety, and innovation.

We also have a network of installer partners, carefully chosen for their professionalism, reliability, and commitment to safety. They ensure your project is completed to the highest standards.

OUR STRENGTHS

Valcan is renowned for its exceptional dedication to providing top-tier, secure, and innovative solutions in the facade industry. Our principal products and systems boast non-combustibility, earning A1 /A2 fire ratings and setting the gold standard for rainscreen systems.

This commitment to quality is propelled by rigorous research and development, ensuring that every solution we deliver is expertly tailored to cater to each project's unique needs and demands. Whether you're undertaking a new build and recladding projects, Valcan guarantees optimal performance, safety, and integrity in every product.

We take pride in being a supportive partner to our customers, guiding them through each project phase and helping them achieve their objectives.



WHAT IS VITRADUAL®?

VitraDual is a 2mm or 3mm non-combustible aluminium cladding system manufactured by Fairview that can be installed as riveted or cassette fixed panels.

VitraDual forms part of our range of industry compliant, non-combustible aluminium panel solutions. The solid aluminium panel is durable and high impact resistant which can be curved and rolled.

VitraDual features the PVDF coating system; well proven for its superior quality, extensive colour range and integrity; unlike traditional 3mm powder-coated aluminium.

Panels are pre-finished; the flexibility of PVDF coatings means they do not require fabrication prior to coating like traditional powder-coated cassettes, thus minimising lead-times, damage and costs.

BENEFITS OF VITRADUAL®

- ▲ **Non-combustible** – A1* rated to BS EN 13501-1
- ▲ **Lightweight** – Valcan VitraDual is incredibly rigid and lightweight and is therefore also easy to install.
- ▲ **Versatile** – Valcan VitraDual can be custom designed into a wide range of shapes and dimensions as well as able to be perforated or curved in some applications making it a versatile design choice.
- ▲ **CWCT & BBA* Accredited**
- ▲ **High Durability** – Valcan VitraDual panels are highly durable and impact resistant. They can be used effectively in high-traffic areas.
- ▲ **Paint System** – Valcan VitraDual only use the highly recognised PVDF KYNAR 500 or FEVE paints known for their high durability, providing the optimum resistance to weather and industrial pollutants.
- ▲ **Maintenance** – easy to maintain compared to polyester-based coatings.
- ▲ **Warranty** – VitraDual has up to a 30-year warranty.
- ▲ **Extremely Flat** – Low Surface Stress.
- ▲ **VitraVerse™ Complete System** – Can be purchased separately or as part of a complete non-combustible A1 rated cladding system VitraVerse™

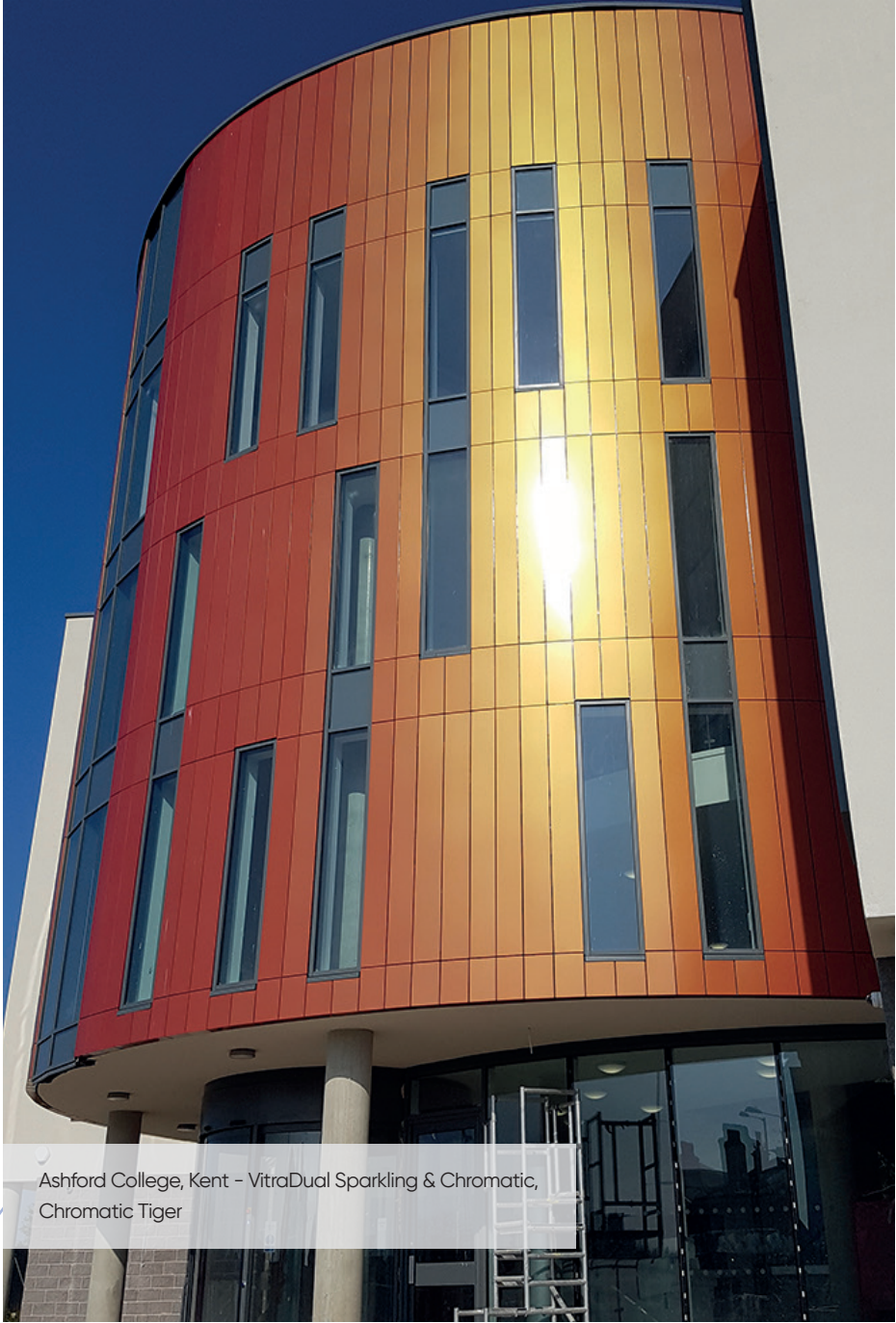

Ashford College, Kent - VitraDual Sparkling & Chromatic, Chromatic Tiger

VITRADUAL[®] PRODUCTION PROCESS

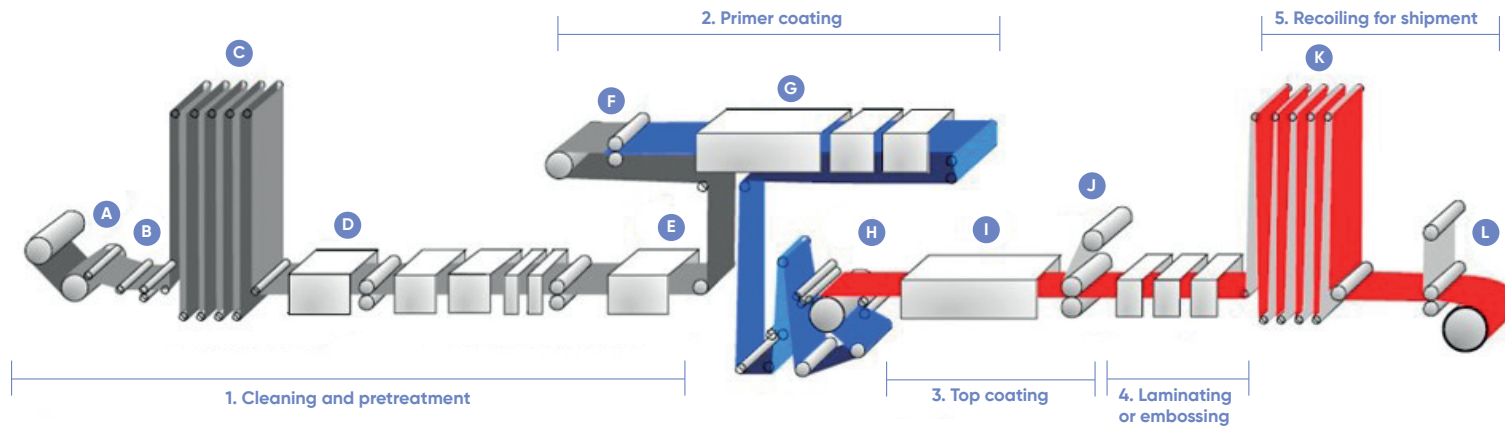

- A** Bare metal is uncoiled
- B** Coil splicing
- C** Accumulator stack (entry)
- D** Metal degreasing, cleaning, rinsing & chemical pretreatment
- E** Drying oven
- F** Primer unit - one or both sides

- G** Curing oven
- H** Coating unit-top coat applied one or both sides
- I** Curing oven
- J** Laminating-one or both sides, or embossing
- K** Accumulator stack (exit)
- L** Recoiling finished metal

*A1 Fire Rated: Please see [Fire Reports and BBA Certification](#) for Classification Limitations and Criteria.



QUALITY

MANUFACTURING QUALITY

A dedication to the total fulfilment of our client's and customer's expectations is reflected by a complete quality control system, beginning at the point of specification and continuing through to delivery of our products.

All activities are carried out in a manner which:

- Uses the framework of ISO9001 Quality Standards to verify the quality of our systems.
- Ensures that our products and services are of the highest standards.
- Create continuous improvements to our product through the application of the best quality practices.



Certificate number: 16388
ISO 9001
ISO 14001

ACCEPTABLE VARIATION

WIDTH	± 2.0 MM
LENGTH	± 4.0 MM
THICKNESS	± 2%
BOW	Maximum 0.5% of the length and/or width
SQUARENESS	Maximum 5.0MM
SURFACE DEFECTS	The surface shall not have any irregularities such as dents, scratches and other imperfections in accordance with our quality assurance.



Premier Inn, Waterloo – VitraDual Grey White and Signal White – Cassette Fix

TESTING AND SPECIFICATIONS:

FIRE RESISTANCE

In today's architecture, it is the technical details, as well as the appearance that count; such as sustainability, thermal insulation, and fire performance.

VitraDual is one of the few large format cladding panels that are truly 100% non-combustible achieving A1* when tested to BS EN 13501-1 on any colour and a wide range of substrates. Also tested to BS8414-2 for fire performance of external cladding systems and compliant to BR135 requirements, VitraDual gives insurers, architects, contractors and building owners peace of mind on product specification. The tested system for BS8414/BR135 provides minimal lateral damage, this means should a fire occur in a room and break out, only a small area of the façade should need replacing.

Visually, VitraDual is similar to traditional composite panels, however, what makes it different is the fact that it is constructed from 100% aluminium, rather than combustible material such as polyethylene and fire rated mineral. This makes VitraDual, an ideal product for all applications where non-combustible panels are required; such as high-rise buildings, schools or hospitals. As with all building products, the use of VitraDual must be authorised by the regulatory body.



A1 rated to
BS EN 13501-01



Tested to BS8414
& BR135 compliant



The Fire Resistance standards achieved with standard VitraDual are as follows:

VitraDual	
TEST STANDARD	RESULT
BS EN 13501-1	A1* / Non-Combustible in any colour
BS8414 / BR135	Pass / Compliant

*A1 Fire Rated: Please see [Fire Reports and BBA Certification](#) for Classification Limitations and Criteria.



PARAMETER	RESULTS	
	FIRE SPREAD TEST RESULT TIME TS (MIN)	COMPLIANCE WITH PARAMETERS IN ANNEX A BR135:2013
External Fire Spread	> 15 minutes	Compliant
Internal Fire Spread (Cavity)	> 15 minutes	Compliant
Internal Fire Spread (Insulation)	> 15 minutes	Compliant

TESTING AND SPECIFICATIONS:

CWCT TESTING

VitraDual panels have been tested and accredited in both flat sheet rivet and cassette panel systems to CWCT wind testing standards.

The panels were tested in 3mm flat sheets and both 2mm and 3mm thickness cassette panel fix.

Copies of the CWCT certificates are available upon request from the Valcan technical team or on the [website](#).

Flat sheets have been fixed to rails with stainless steel rivets at maximum spacing of 600 mm:



Wind resistance	PASS
Serviceability test	2400Pa
Safety test pressure	3600Pa
Rainscreen system	Valcan rainscreen with VitraDual panels supported on VitraFix vertical rails
Panel description	Flat Sheet & Cassette

Windloading	Rivets at 500mm centres	Rivets at 600mm centres
600 PA	X	X
1200 PA	X	X
1800 PA	X	X
2400 PA	X	





Cassettes formed by double folding panel edges, the aluminium was factory grooved before folding - residual thickness after grooving 0.8-1.0mm.

Cassettes with shorter dimension greater than 1000mm provided with stiffeners across the short dimension of the panel, these were spaced at centres shown below.

Stiffeners formed of 2mm aluminium folded to form top hats with overall width of 150mm and height of 25mm. Stiffeners fixed to back of panels using stud welds.

Cassettes fixed to carrier rails using VitraFix self-drilling fixings through flanges at panel edges; flanges of adjacent panels overlap to create a closed jointed system. Fixing locations at maximum 600mm spacing in vertical joints and at each rail in horizontal joints.

HEIGHT (MM)	WIDTH (MM)	STIFFENERS	STIFFENER SPACING
3000	1250	3 No horizontal	750 c/c
2000	500	None	N/A
2000	250	None	N/A
1250	3000	3 No vertical	N/A
1000	1000	1 No vertical	N/A
1000	750	None	N/A
800	800	None	N/A
800	200	None	N/A
700	200	None	N/A
500	2000	None	N/A
300	800	None	N/A
250	2000	None	N/A
250	800	None	N/A
250	200	None	N/A
200	800	None	N/A

Information in table based on 2mm VitraDual

For the full certificate please refer to our [website](#) or scan the QR code: 



Morfa Road, Swansea - VitraDual Custom Colours:
Patina Copper and wood effect

TESTING AND SPECIFICATIONS: THE BRITISH BOARD OF AGREEMENT (BBA)

VitraDual (3mm) has also been accredited by **BBA**.

Download the full certificate from our website www.valcan.co.uk



KEY POINTS FROM THE CERTIFICATE:

England & Wales, Scotland and Northern Ireland regulations:

"VitraDual panels are unrestricted by regulations relating to internal and external fire spread."

Under Section 7, Behaviour in relation to fire:

"The panel is classified as non-combustible and is not subject to any restriction on building height or proximity to boundaries."

Under Section 10, Durability:

"When incorporated in an overall wall cladding system, the panel should have a service life of at least 30 years if designed, installed and maintained in accordance with this certificate."

Under Section 11, Reuse and recyclability:

"The product is manufactured from aluminium which can be recycled."

TESTING AND SPECIFICATIONS: ENVIRONMENTAL PRODUCT DECLARATION (EPD)



VitraDual® 2mm or 3mm non-combustible aluminium panel is registered with The International EPD System - Registration number: S-P-04405. En15804 compliant.



VITRADUAL®

THERMAL PERFORMANCE

For external installation of VitraDual with rivets, the thermal expansion must be taken into consideration. The hole in the panel must be larger than the fixing to allow for movement.

The thermal extend coefficient of aluminium is 0.0232mmmm/°C.

Calculation of the temperature difference must be based on

the anticipated minimum and maximum temperatures of the panel when exposed to extreme climatic conditions at the site of the installed panels.

A white panel in a hot environment would reach up to 50°C in direct sunlight, whereas a dark coloured panel in the same conditions could reach 80°C.

THERMAL INSULATING PROPERTIES

THERMAL RESISTANCE		
FROM -50°C TO +80°C		
Panel Thickness (mm)	Thermal Resistance 1A M2.K/W	Heat Transmission Coefficient W/M2.K)
3	0.0069	5.65

MATERIAL	EXPANSION COEFFICIENT (X10 -6/°C)	ELONGATION PER 1000MM T=50°C
VitraDual	23.8	0.0232MM/M/°C
Aluminium	23.8	0.0232MM/M/°C
Stainless Steel	26.7	0.0166MM
Steel	12.2	0.0120MM



IQ Student Accommodation, Bristol - VitraDual Midnight Blue, Ocean Depths, Bleached Mint, Lapis Blue, Mint Green, Stormy Sky, Green Slate and Electric Blue- Rivet Fix

VITRADUAL® COLOURS & FINISHES

VitraDual is available in our extensive range of standard colours and finishes, as well as a custom colour match option. This helps to ensure reclads meet the current aesthetics ensuring easy planning consent but still achieving the requirements of Approved Document B, regulation 7.

Valcan VitraDual uses the well known Kynar PVDF 80/20 coating system technology which boasts superior quality and our full-colour matching range as well as RAL colours, stone and wood effect finishes.

Valcan VitraDual cladding panels are prefinished, so they do not need fabrication before the coating process - this is unlike standard powder-coated systems and results in lower costs and reduced lead times.

We maintain high stock levels of VitraDual, which means we can minimise lead times for your project - contact us to check stocks on +44(0)1278 428 245.

SOLID COLOURS



METALLIC COLOURS



CHROMATIC COLOURS



NATURLINE COLOURS



STONECREATE COLOURS



WOODCREATE COLOURS

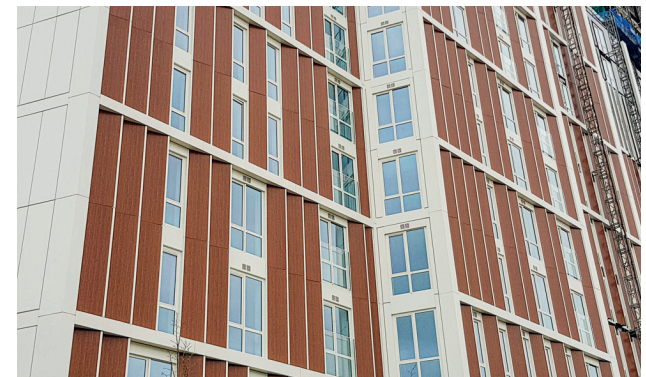

EXPRESS RANGE

This range are held as standard stocked colours available for short delivery lead times and lower minimum order quantities.



9601
Silver
Metallic

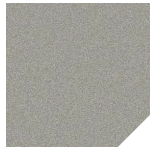

9205
Champagne
Metallic

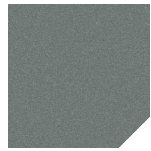

9134
Smoke Silver

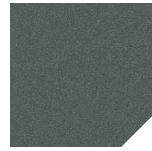

9137
Dark Grey
Metallic

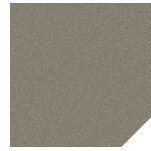

9308
Bronze
Metallic



4150
Gold
Metallic

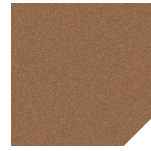

9809
Copper
Metallic



8400
Warm Oak

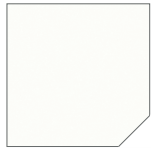

9902
White



9210
Frost White



9304
Cool Grey



9504
Crux Grey



1255
Riddle Grey



9130
Enigma
Black

NON EXPRESS RANGE

This range of colours consists of standard but non-stocked colours, lead times and minimum orders quantities may apply, contact us to discuss.



10008
Seal Grey



1510
Fresh Green

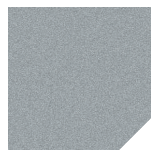

9701
Silver Ice
Metallic



4240
Sunshine
Grey



7085
Chromatic
Gold Dust

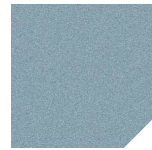

4420
Blue Grey
Metallic



7090
Chromatic
Ice



7450
Chromatic
Diamond
Purple



7550
Jungle
Green



7690
Chromatic
Ancient Red



Golden Ash



Soft Pine



Pacific Yew



Teak

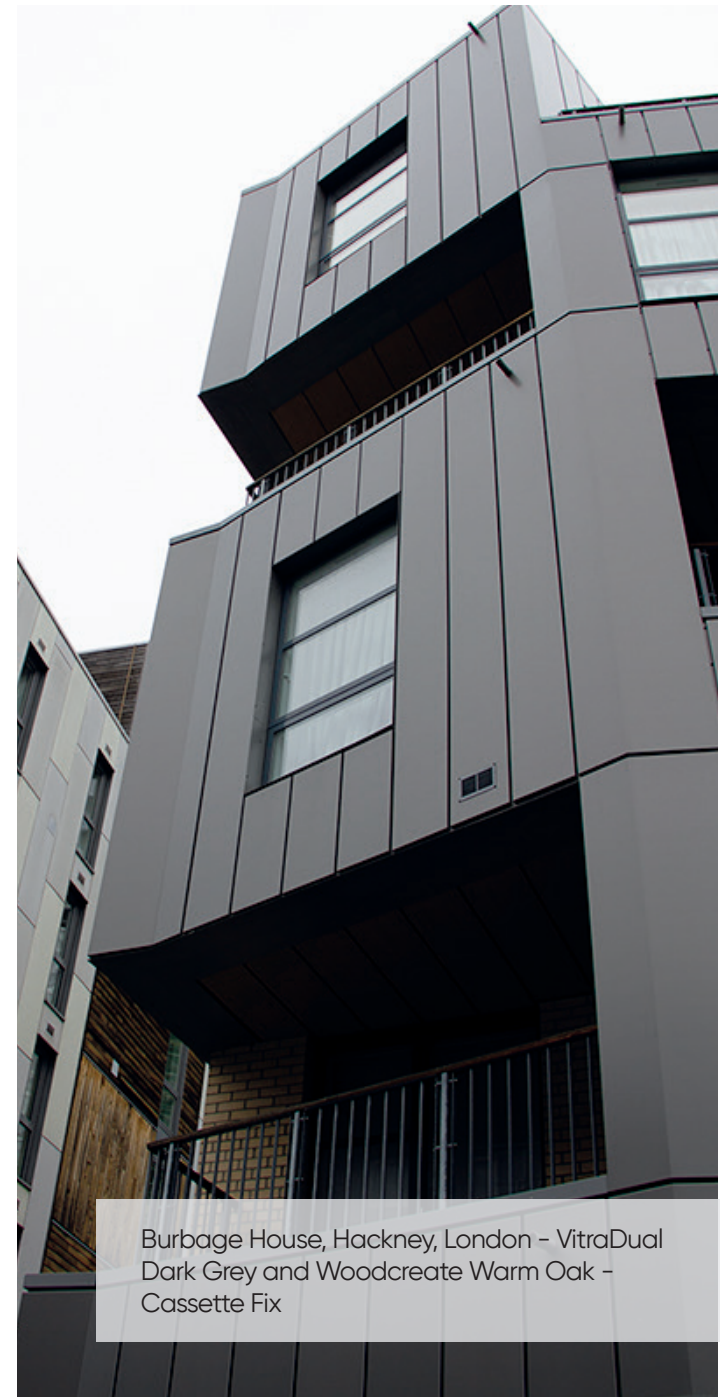

Burbage House, Hackney, London - VitraDual
Dark Grey and Woodcreate Warm Oak -
Cassette Fix

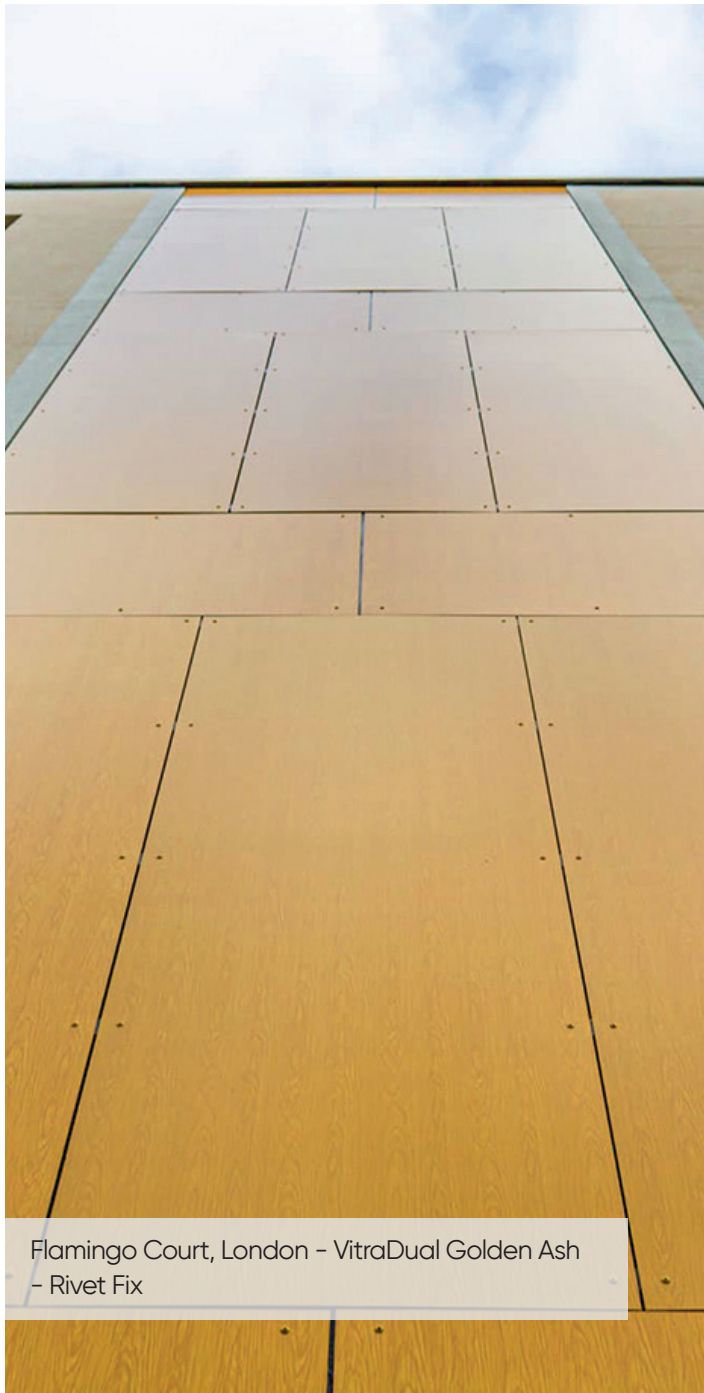

Flamingo Court, London - VitraDual Golden Ash
- Rivet Fix

NON EXPRESS RANGE - CONTINUED

						
8805 Dark Kingwood	Dark Teak	5362 Corten 3	5363 Corten 4	5571 Patina Green 2	5570 Patina Green	6003 Concrete 3
						
6002 Concrete 2	6001 Concrete 1	1005 Snow White	RAL 7026 Granite Grey	3221 Bleached Mint	3032 Mint Green	6027 Light Green
						
1599 Forest Green	1420 Reef Blue	10002 Lapis Blue	10001 Midnight Blue	10007 Electric Blue	1125 Cool Yellow	1135 Sunshine Yellow
						
1677 Poppy Red	1686 Power Red	Any RAL Colour				

COMPLIMENTARY SAMPLES

Should you find a range of colours suitable for your project you can order up to three samples sent directly to you free of charge. Simply [order online](#) or contact the Valcan team.



If you require to see a larger range of colours or finishes you'll need to setup an appointment with one of our facade experts. They'll be happy to meet you either on-site, or at your premises.

VITRADUAL® COLOURS FASTNESS

Kynar 500® resin is a special grade of PVDF resin used by licensed industrial paint manufacturers as the base resin in long-life coatings for aluminium, galvanized steel, and aluminium steel.

- Made without the use of a fluorosurfactant
- Extreme weatherability
- Excellent dirt shedding
- Superb mildew resistance

FLORIDA EXPOSURE 45° SOUTH. 17 YEARS EXPOSURE

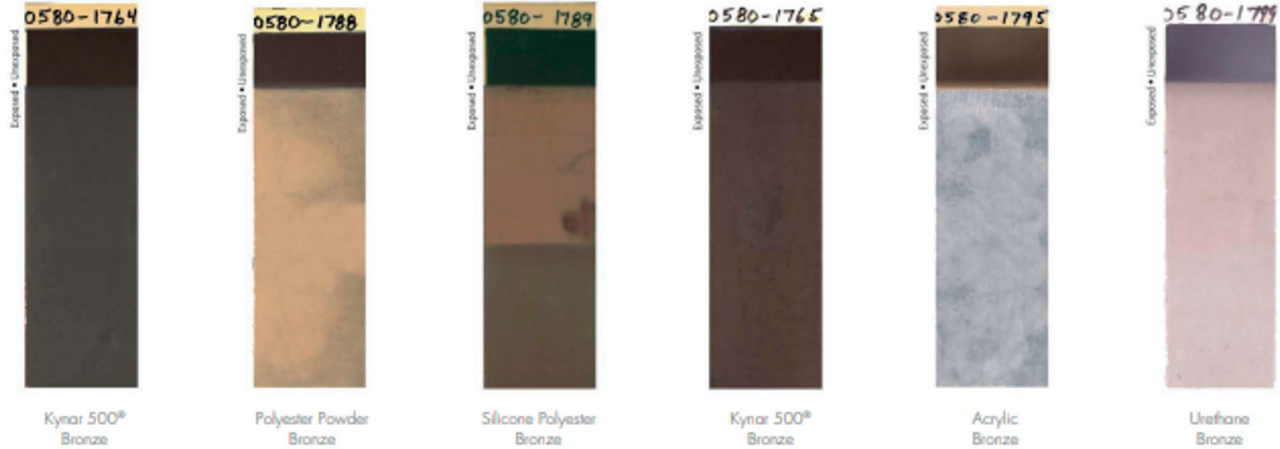

FLORIDA EXPOSURE 45° SOUTH. 10 YEARS EXPOSURE

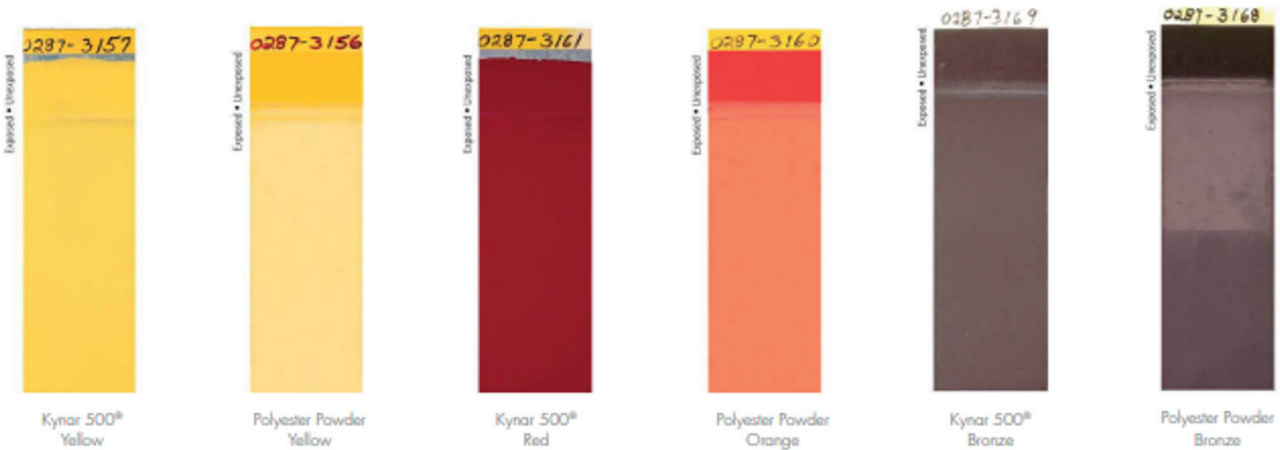

ARKEMA

VITRADUAL® MATERIAL PROPERTIES

TYPICAL COMPOSITION

1. Protective film
2. PVDF-Kynar 500 coating system
3. 2mm or 3mm Aluminium
4. Rear Coating

The material is rigid, resistant to blows, breakage and pressure, and has high bending, buckling and breaking strengths.

ALUMINIUM

VitraDual is manufactured from 3000 or 5000 series aluminium for machinability and exterior performance, other aluminium grades available as required for projects.

DIMENSIONS

WIDTH	LENGTH	THICKNESS
1250/1500	2500	2MM / 3MM
1250/1500	3200	2MM / 3MM
1250/1500	4000	2MM / 3MM

Custom sizes are available - Please speak to the Valcan team

WEIGHT

THICKNESS	WEIGHT (KG/M ²)
3 MM	8.13
2 MM	5.42

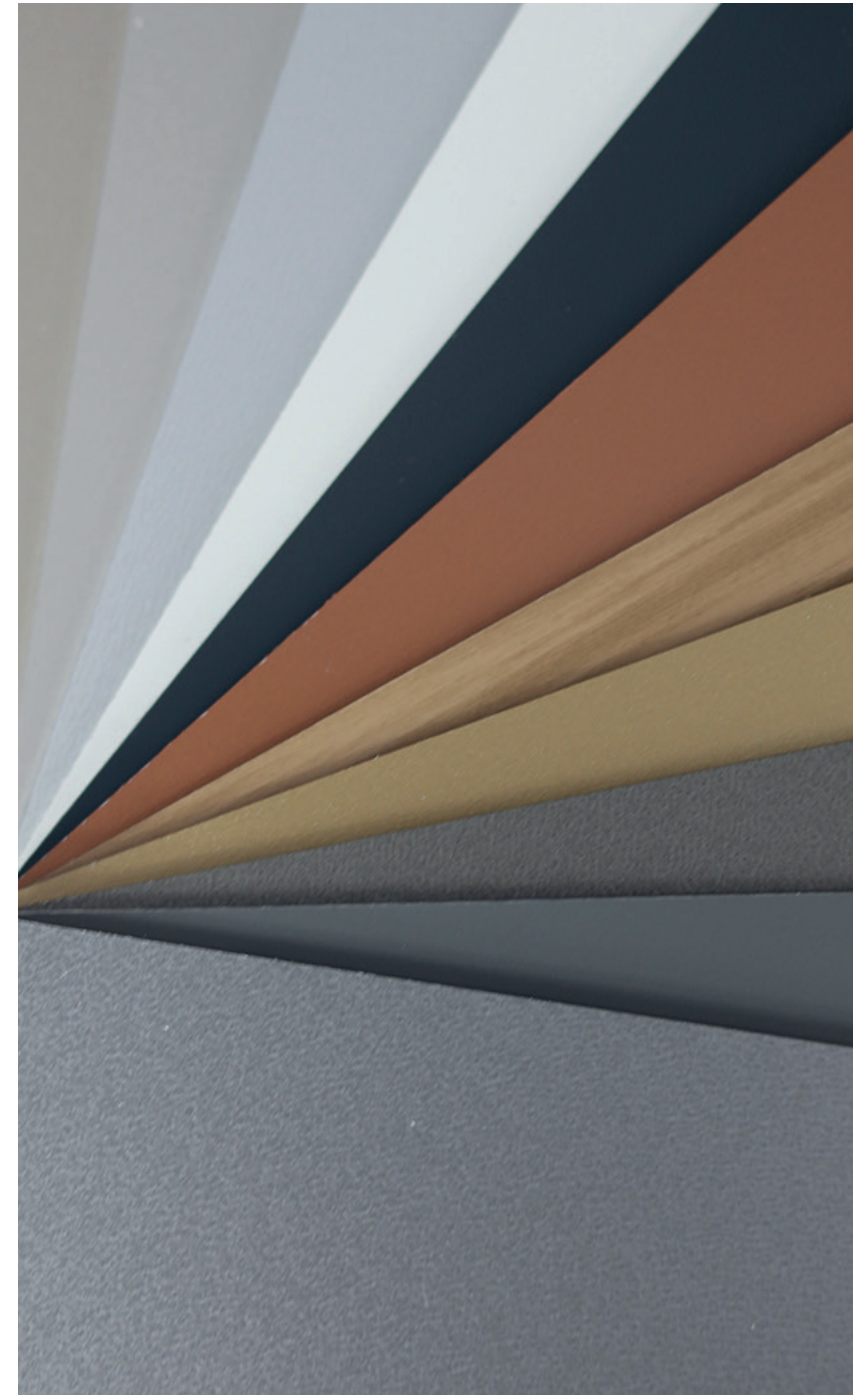

TECHNICAL DATA - Based on 5754/H22 grade, other grades available

PHYSICAL PROPERTY	VALUE
Density	2.66 G/CM ³
Melting Property	600 °C
Thermal Expansion	24 x 10 ⁻⁶ / K
Modulus of Elasticity	68 GPA
Thermal Conductivity	147 W / MK
Electrical Resistivity	0.0495 x 10 ⁻⁶ Ω M
Tensile Strength	220 - 270 MPA
Proof Stress	130 MIN MPA
Hardness Brinell	63 HB
Acoustic Insulation	RW 27

LOAD (KN/M ²)	MAX SPAN (M)	
	VitraDual 2MM	VitraDual 3MM
0.50	1.00	1.50
1.00	0.71	1.06
1.50	0.58	0.87
2.00	0.50	0.75
2.50	0.45	0.67
3.00	0.41	0.61
3.50	0.38	0.57
4.00	0.35	0.53



Cardiff Bus Interchange - Installation of VitraDual Power Red - Cassette Fix

TECHNICAL DATA OF KYNAR 500 PVDF COATING

CLASSIFICATION	TEST STANDARD	RESULT	REMARKS
Substrate	ASTM D1005	PASS	Aluminium
Flexibility	ASTM D4145 ECCA T7 NCCA 11-19	PASS	1-2T - No Cracking
DFT	ASTM D1400 ASTM D1005 NCCA 11-13, 14, 15	PASS	
Colour Difference	ASTM 2244	$\Delta E < 5$	4,000 HRS
Gloss Meter	ASTM D523	PASS	
Gloss Retention	ASTM D2244	85%	4,000 HRS
Chalking Resistance	ASTM D2244	<8 units	4,000 HRS
Pencil Hardness	ASTM D3363		
Dry Film Adhesion Wet Adhesion Adhesion		PASS PASS PASS	38°C, 24 HRS 100°C, 24 HRS
Reverse Impact Resistance	ASTM D2794	NO CRACKING	12.7 MM x 0.5 KG x 500 MM
Bending/Gardner Impact	ASTM D3281	PASS	Normal
Solvent Resistance	ASTM 2794	PASS	MEK Double Rubs
Acid Resistance	ASTM 1308	PASS	7 Days Soaking in 10% H2SO4
Alkali Resistance	ASTM 1308	PASS	7 Days Soaking in 10% NAOH
Detergent Resistance	ASTM D2248	PASS	72 Hours Soaking in 3% Detergent

CLASSIFICATION	TEST STANDARD	RESULT	REMARKS
SALT RESISTANCE	ASTM B117	INCLUDES THE FOLLOWING:	
Gloss Retention	ASTM D523	0.8% Change	5,000 HRS
Colour Retention	ASTM 2244	$\Delta E < 0.68$	5,000 HRS
Chalk Resistance	ASTM 4214	Rating: 10	Top Rating - No Chalk (5,000 HRS)
HUMIDITY RESISTANCE	ASTM D714	PASS	2,000 HRS
	ASTM B117	INCLUDES THE FOLLOWING:	
Gloss Retention	ASTM D523	NO VISIBLE CHANGE	5,000 HRS
Colour Retention	ASTM 2244	$\Delta E < 0.52$	5,000 HRS
CHALK RESISTANCE	ASTM 4214	Rating: 10	Top Rating - No Chalk (5,000 HRS)
WEATHERING RESISTANCE	ASTM G53	INCLUDES THE FOLLOWING:	
Gloss Retention	ASTM D523	6.2% Change	5,000 HRS
Colour Retention	ASTM 2244	$\Delta E < 0.27$	5,000 HRS
Chalk Resistance	ASTM 4214	Rating: 10	Top Rating - No Chalk (5,000 HRS)
CHEMICAL RESISTANCE	ASTM C207	PASS	Mortar, 24 HRS
	ASTM D1308	PASS	10% HCL, 15 MIN
		PASS	70% HN03 Vapours, 30 MIN
	INCLUDES THE FOLLOWING:		
Gloss Retention	ASTM D523	6.2% Change	16 HRS
Colour Retention	ASTM 2244	No Change	16 HRS
Chalk Resistance	ASTM 4214	Rating: 10	Top Rating - No Chalk (5,000 HRS)

VITRADUAL®

FIXING OPTIONS - CASSETTE SYSTEMS

To ensure the best installation is completed, we recommend the use of our VitraFix® framing system and accessories – for more information on installation accessories, contact the team at Valcan or visit the [website](#).

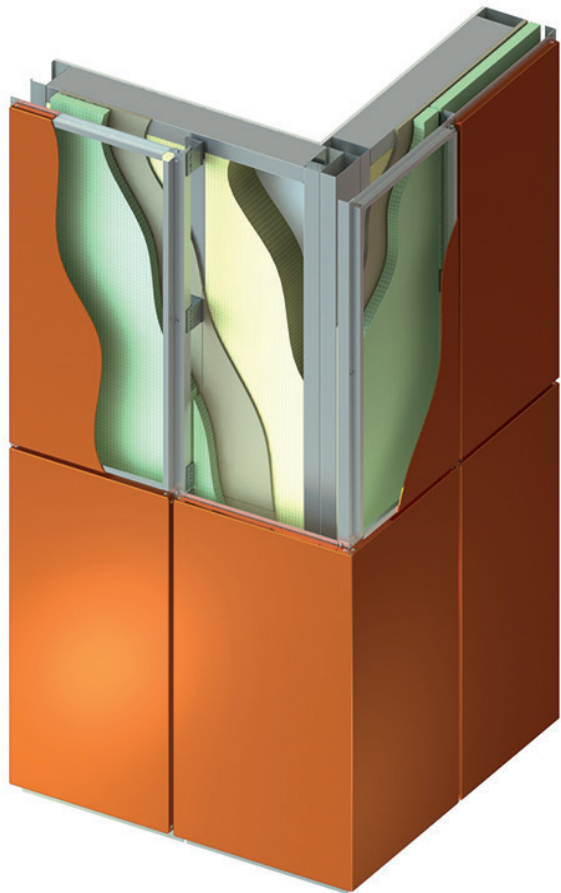

To obtain a cleaner looking face to the facade, the cassette system utilises folded panels with colour matched fixings installed in the recess where the panel joints overlap.

This system utilises the same VitraFix VF1 system as used on the rivet fix option.

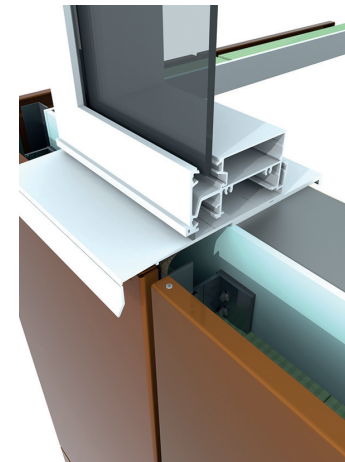
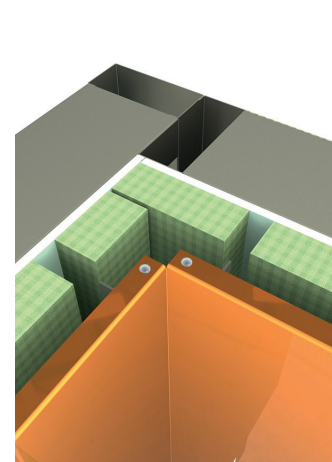
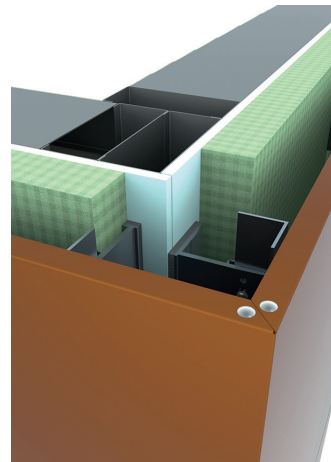
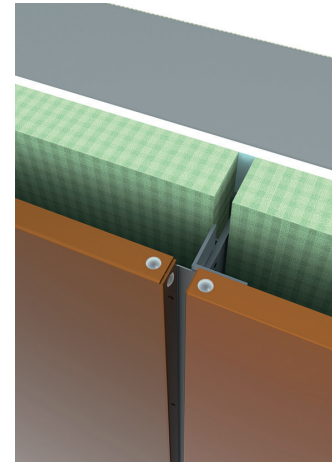

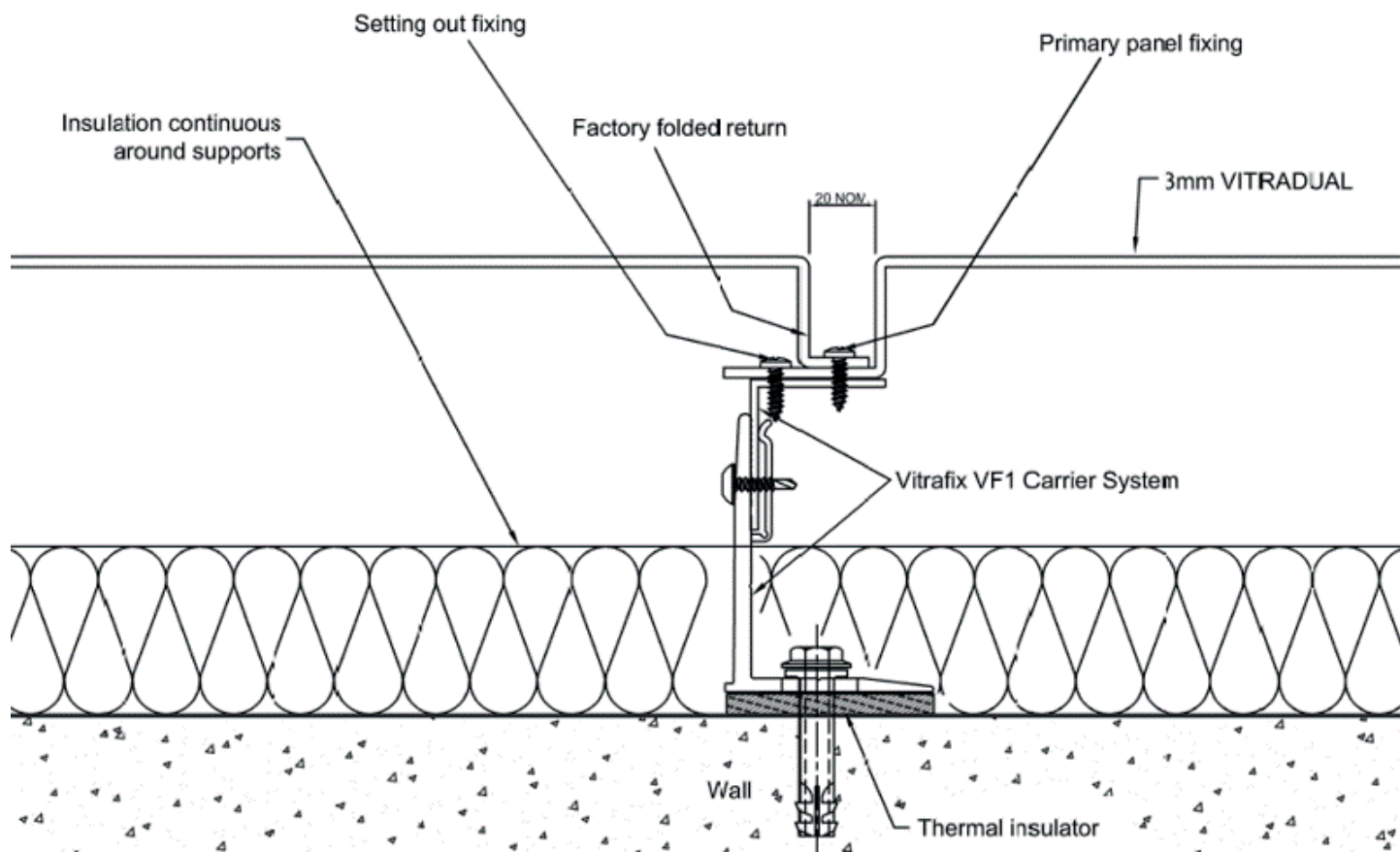

VITRADUAL®

FIXING OPTIONS - CASSETTE SYSTEMS

FIXING SPECIFICATION

A4 stainless VitraFix pan head fixings should be used, there are 2 sizes available depending on build up of the system = 5.5x25 mm (suitable for up to 12mm depths) and 5.5 x 35mm (suitable for up to 22mm depths).

FIXING HOLES/POSITIONS

Fixings should be installed in the panel reveal/joint at centres of 600mm (maximum) vertically up the rail/joint (based on a vertical carrier system install) and at each rail location in the horizontal joints.

Hole size should be 6mm diameter – it may be necessary to include floating holes to allow for thermal movement, the size and locations of these will be the responsibility of the designer/engineer working on the project.

A minimum of 1 fixed points (6mm diameter) should be included per panel, 2 may be required as an aid to restrict the panel moving while installing fixings – the location and number of fixed points will be the responsibility of the designer/engineer working on the project.

PANEL STIFFENERS

Stiffeners may be required in cassette panels depending on wind loading applicable to the project, these should be stud-welded into the panel (rather than adhesively fixed) and the size/positioning of these will be as per Valcan's VitraDual CWCT test report 2020/96D ([See page 10](#)).



A4 pan head fixings



Find out more about VitraFix Subframe Systems and fixings on the Valcan [website](#)

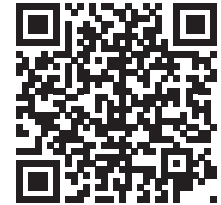



RUH Dyson Cancer Centre, Bath - VitraDual Copper Metallic - Cassette Fix

VITRADUAL[®]

FIXING OPTIONS - RIVET FIX SYSTEMS

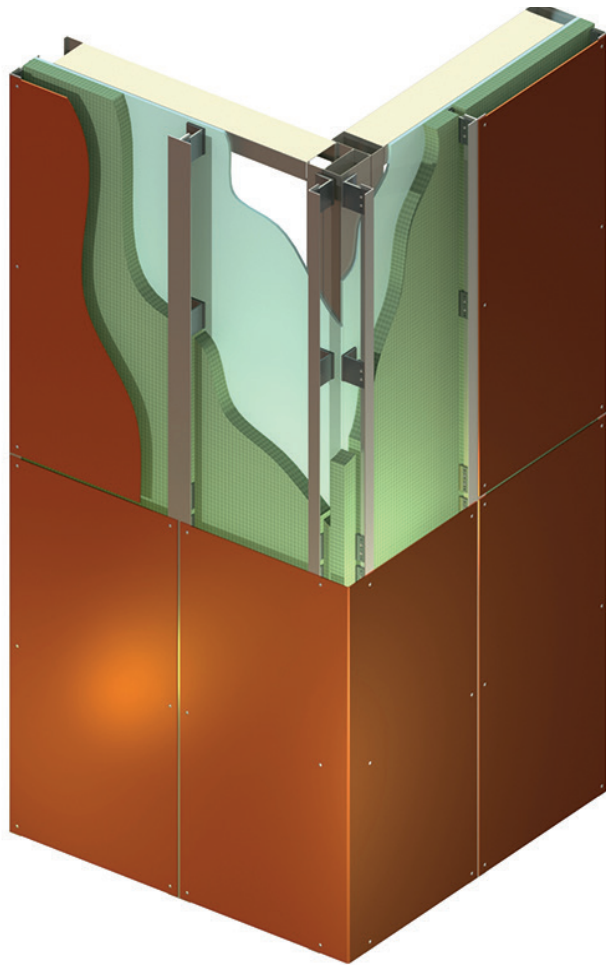

Rivet Fix is the simplest and most cost effective way of installing façade panels.

This method uses colour matched rivets to secure the panels back to the VitraFix VF1 carrier frame.

The use of colour matched rivets allows a semi discrete installation method.

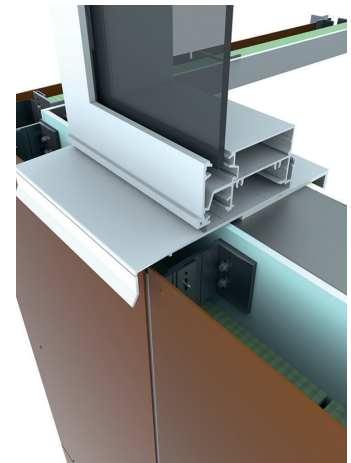
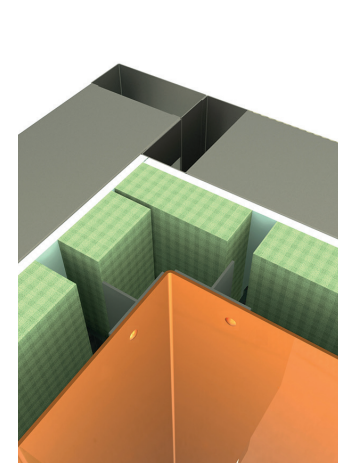
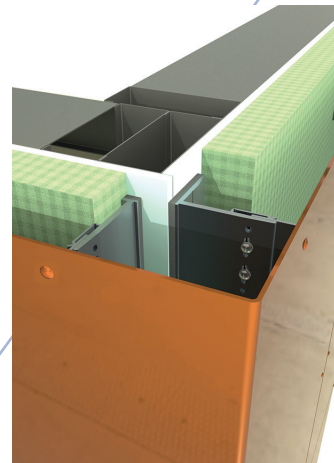
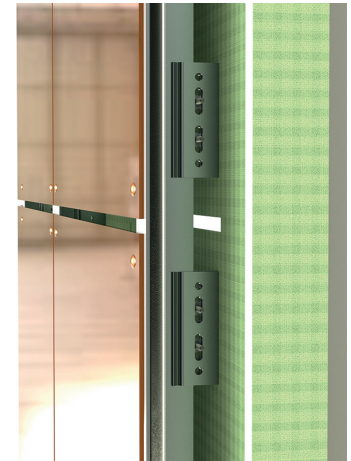
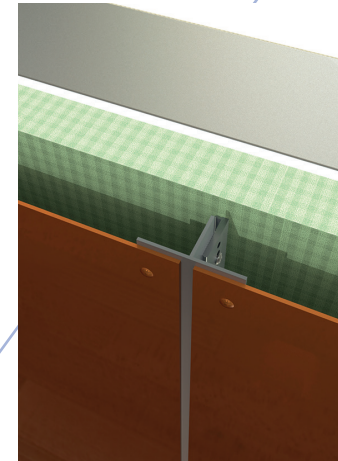

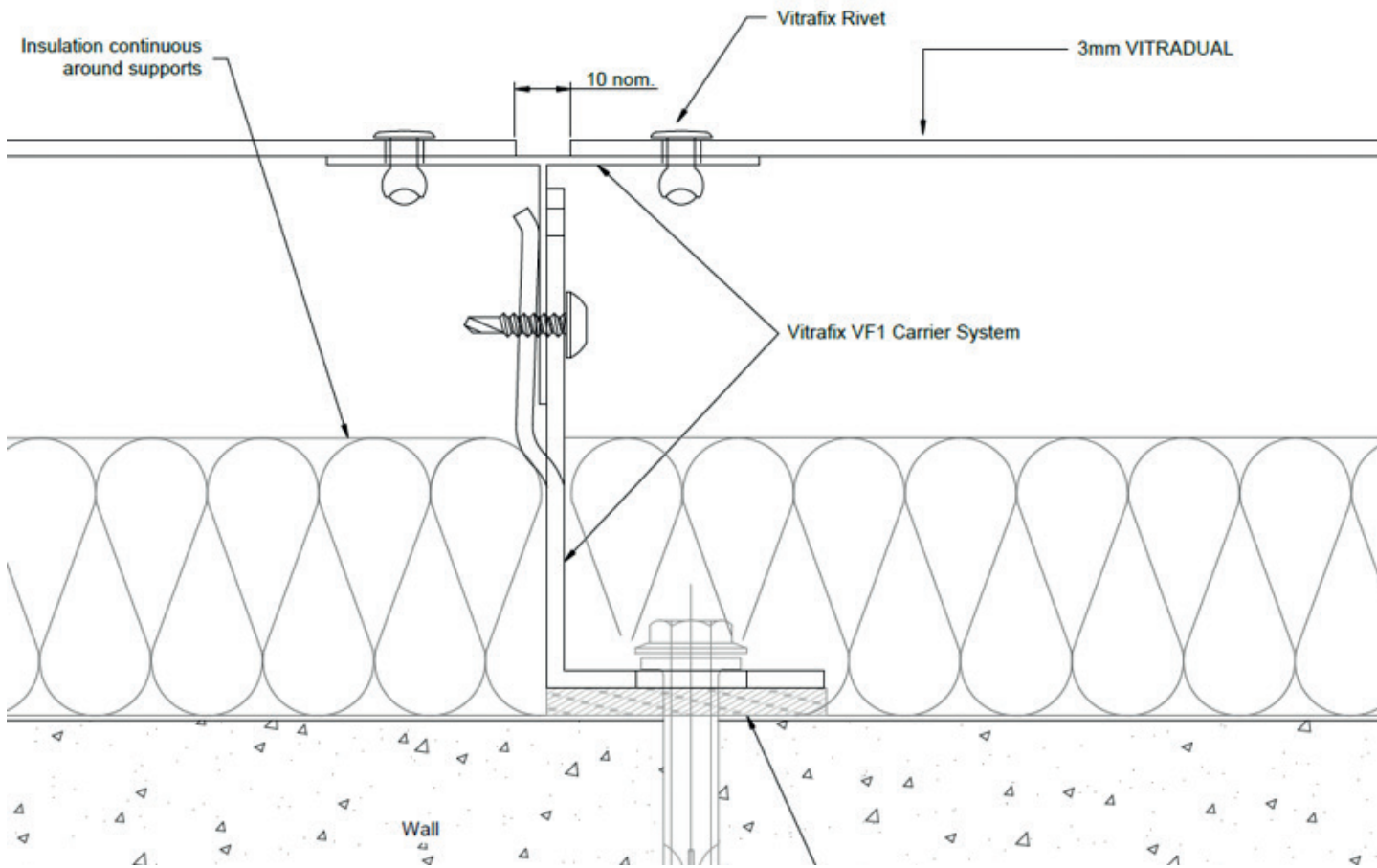

VITRADUAL®

FIXING OPTIONS – RIVET FIX SYSTEMS

FIXING SPECIFICATION

Rivets used should have a body diameter of a minimum 4.8mm and a head size of 11-16mm, for different sized rivets, or for information about colour matching rivets please contact the Valcan team to discuss.

The standard VitraFix rivets have a head size of 16mm and a body of 4.8mm with a body length of 20mm, these are “multi-grip” rivets offering 5.0-13.0mm grip range – product reference is below, these can be colour matched to any of our panels:

VFR4.820A4, VitraFix Rivet, A4, 4.8x20mm with 16mm head – these are packed in 200/box

The VitraFix VFR4.820A4 rivet has a shear strength of 4000N and a tensile strength of 5000N. This rivet is manufactured in A4/marine grade stainless steel so is suitable for both inland and coastal applications.

For an aluminium support system that is in direct contact with the panel (no thermal isolator used), the difference in the temperature between the two materials would not exceed 10°C.

Consequently, a reduced allowance for thermal expansion in the direction of the carrier system of 0.24mm/1m length can be made, but the traverse expansions is to be taken into account fully

Rivet heads must have a minimum of 1mm overlap onto the panel and must be concentrically positioned.



VitraFix Rivet, A4

A VitraFix Rivet Adapter is recommended to be used on the rivet tool to allow 0.3mm tolerance between the panel face and the rivet head. This is to prevent the panel from being ‘pinched’ too tightly, therefore not allowing the VitraDual panel to move, and pulling in the face of the panel causing unsightly denting to the surface. It is important to ensure that the correct nose piece adapter is used to suit the profile of the rivet head and diameter – please discuss with the Valcan team.

To ensure the rivet hole in the substrate is centred in the panel hole, it is recommended that either a VitraFix Centralising Tool or a VitraFix Step Drill is used with the depth stop set to the thickness of the panel.

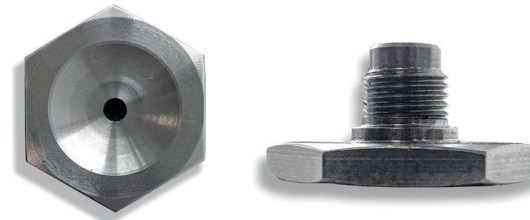

VitraFix Rivet Adapter



VitraFix Centralising Tool



Empire Court & Gantry Court, Southampton - VitraDual RAL matched colours - Rivet Fix

VITRADUAL®

FIXING OPTIONS - RIVET FIX SYSTEMS

FIXING AND POSITIONING OF THE RIVETS

When face fixing panels, it is recommended to have 1 fixed hole per panel and the rest as sliding holes. The fixed hole should be centre if possible however if centre fixing is not possible due to panel size, this can be top right or left on every panel installed.

Fixed holes should be 5mm in diameter and sliding should be 7.0-8.5mm in diameter depending on the panel colour being installed. It is recommended that the sliding hole dimension is checked by a qualified and competent façade engineer.

The diameter of the hole in the substructure should be 4.9mm and centered in hole in the panel.

To ensure the rivet hole in the substrate is centred in the panel hole, it is recommended that either a VitraFix Centralising Tool or a

VitraFix Step Drill is used with the depth stop set to the thickness of the panel.

Fixing centres should be spaced up to a maximum of 600mm depending on wind loadings applicable to the project.

Rivets should be spaced between 16-50mm from the edge of the panel both horizontally and vertically.

The maximum unsupported overhang from a rivet is 150mm and the distance to a corner from the nearest rail/rivet is 300mm.

For Wind-loading information see [page 10](#).

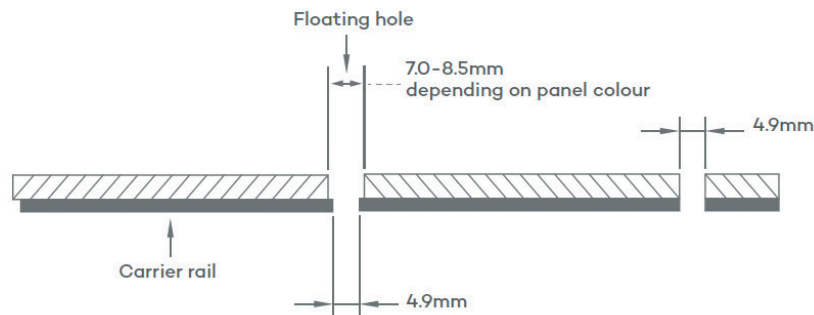

Fulbourne Road, Gallery Court - VitraDual Bold Cream - Rivet Fix

RIVET FIX OVERVIEW DRAWINGS

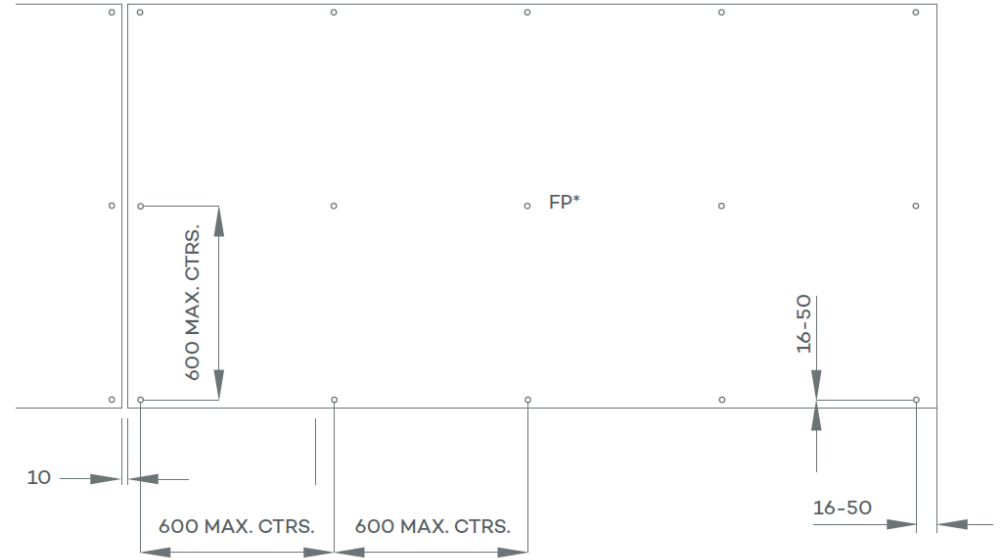
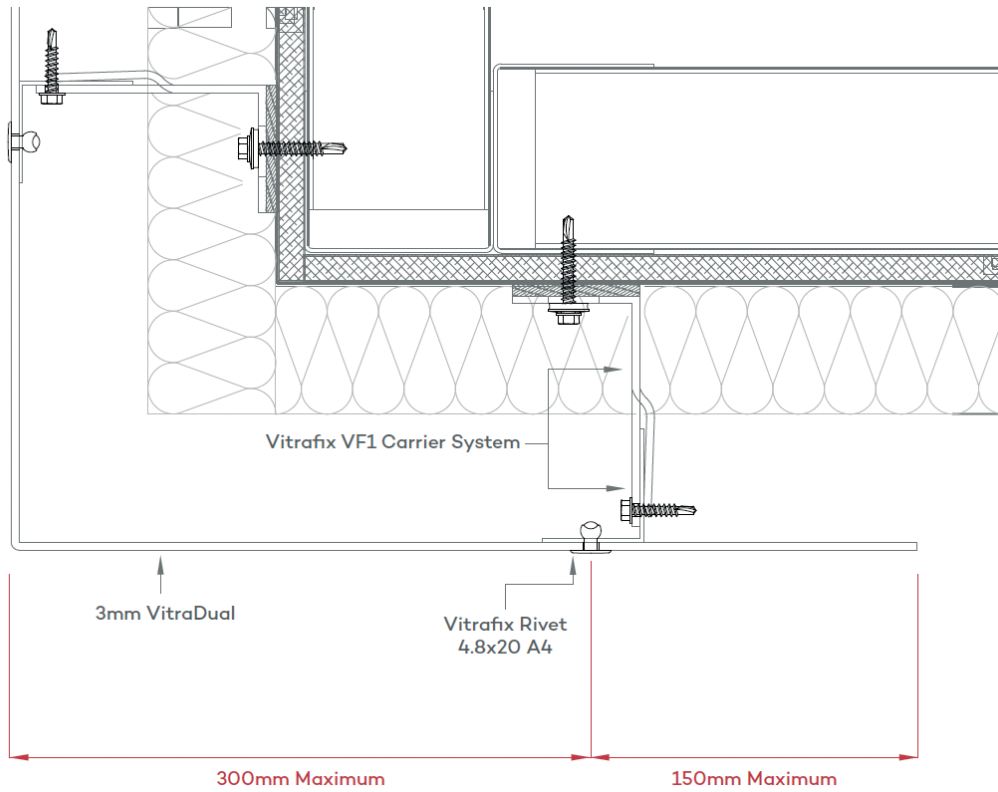

You can download all drawings, certificates and technical info on the [Valcan website](http://www.valcan.co.uk).



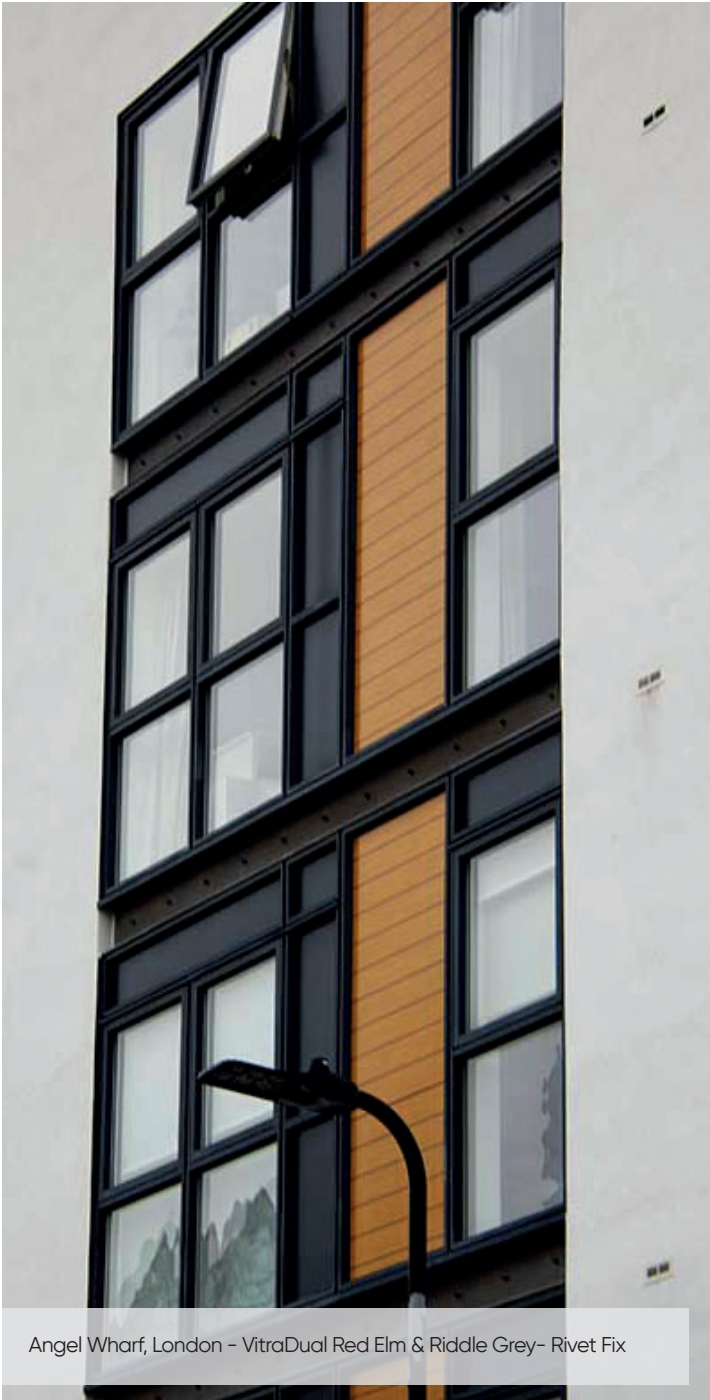

Angel Wharf, London - VitraDual Red Elm & Riddle Grey- Rivet Fix

VITRADUAL®

OTHER FIXING OPTIONS

SECRET FIX WITH HOOK ON

In this system, VitraDual panels are fabricated into “tray” panels with returns on all 4 sides, similar to the cassette fix system. However, instead of fixings being installed in the joints/reveals, the panels are hung onto a vertical profile that is fixed to the building, and fixed through the top ‘flange’ of the tray.

This fixing is then covered by the next panel fixed above – thus ensuring the fixings are always hidden.

Fast to install with no visible fixings – this is the premium fixing method for VitraDual, and can be used for a variety of panel sizes and surface shapes, from small panels right up to large format panels such as 4000 x 1400mm for example. The carrier system to use to support this panel is VitraFix VFX.

PLANKING SYSTEM

In the Planking system, VitraDual panels are fabricated into planks that are installed to the building substrate using the VitraFix VF1 support framing system and a secret fix mechanical fastener.

The planks are overlapped and fixed together as an interlocking system, which provides a continuous, smooth surface without visible fixings. This system is often used for projects where a timber plank alternative is required, or that type of look desired.

The widths and lengths of the planks can be made to your requirements within the parameters of our standard raw sheet sizes.



STANDING SEAM EFFECT SYSTEM

The Standing Seam Effect system is a popular choice for cladding projects where the client requires the standing seam look, but would like to use VitraDual rainscreen system with its superior panel flatness and speed of install.

In this system, the VitraDual sheets are fabricated into panels that are installed vertically or horizontally, with a raised seam running along the edge of each panel, that overlaps the adjacent panel.

The Standing Seam panels are fixed back to the building with a VitraFix VF1 system. The widths and lengths of the panels can be made to your requirements within the parameters of our standard raw sheet sizes.

SCREWING

VitraDual can be screwed with conventional stainless steel or galvanised screws for metal. For outdoor use allow for thermal expansion.



RIVETING

Riveting is possible with the usual equipment and solid rivets or blind rivets. For outdoor use allow for thermal expansion.



Providance House, Maidenhead. VitraDual - Woodcreate Teak - Planking System

VITRADUAL®

FABRICATION METHODS

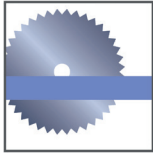

CUTTING

VitraDual can be cut with a wall-saw, circular saw, guillotines, flat bed routers and rail saws. The requirements for a circular saw are identical to that for cutting solid aluminium. for more information see the VitraDual Technical Manual or contact the technical team.

THE CUTTING TOOTH MATERIAL TO BE CARBIDE TIPPED, THICKNESS 2-4MM	
Tooth Geometry:	Trapeze / Flat
Tooth Pitch:	10-12mm
Rake Angle:	-5° (Negative)
Clearance Angle:	15°
Max Cutting Speed:	20m/mm



CONTOUR CUTTING

VitraDual panel can be contour cut with CNC routers, copy routers. Coolant may be required dependant on tooling and machine set up.

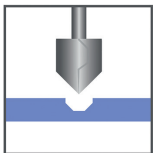

ROUTING/FOLDING

VitraDual panel can be cold shaped, enabling it to form various shapes and sizes. A bullnose, rectangular or V-shaped groove can be routed on the back of the panel, following potential fold lines. The panel can then be hand folded along this groove, creating a precise and even fold. The outer radius of the fold can be determined by the shape and width of the routed groove.

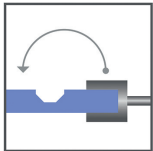

There must be between 0.7mm and 1mm of aluminium left at the base of the routed groove. Too much material can cause stress and result in a larger radius fold than desired. It will also make folding the panel more difficult and prevent the required fold angle from being obtained.



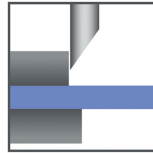

SHEARING

Shearing can be done with a guillotine. Ensure the blanking tools are padded. Shearing causes a slight roll down along the cut edge of the panel.



PUNCHING

The punching of flat formed parts from VitraDual is performed in the same way as a solid aluminium sheeting, using sharp tools and dies with minimal cutting clearance. Varying shapes may easily be punched with normal aluminium punching machinery. As with shearing, a slight roll down may occur.

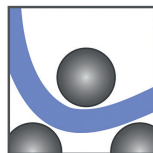

ROLL BENDING

VitraDual panel can be bent with a roll-bending machine. Use polished rollers free of imperfections only. Minimum radius of 200mm.

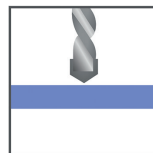

DRILLING

VitraDual panel can be drilled with centre point twist drills normally used for aluminium or machines common for metals. Drill material: High-Speed Steel (HSS).

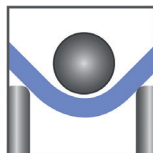

BENDING

Bending is possible with a folding table or brake press. The inside bending radius is roughly 2.5 times the VitraDual panel thickness. Use protective foils. For serial production, tests should be made on sample panels.

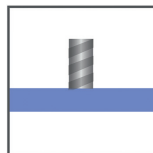

STUD WELDING

It is possible to stud weld to the back of the VitraDual panel without deforming the face of the panel, this can be used for a non-combustible attachment of stiffeners.

- Panels should be fabricated and installed as directional unless consent has been given by the client/architect on the project
- VitraDual – direction is indicated by the arrows on the protective film
- When fabricating and installing VitraDual panels, these must be mixed from the multiple pallets delivered (where multiple pallets have been delivered) rather than working pallet by pallet

VITRADUAL®

STORAGE AND MAINTENANCE

STORAGE

- Panels must be stored flat on pallets
- If sheets are to be removed from pallets, these must be stored flat on bearers spaced no more than 300mm
- For fibre cement panels with a coating, ensure the protective foam is in place between sheets when being stored
- Pallets must be stored inside in dry conditions with covers retained on the pallets to protect from weather and any other works being carried out
- Pallets must be staked no more than 2 high
- Pallets must be stored in a way that allows ventilation to prevent condensation build-up
- It is recommended that panels are only delivered when site is ready for imminent installation to protect against weather and other trades causing damage
- Goods must not be stored in anyway that gives way to standing water on the goods (applies to VitraFix components too)

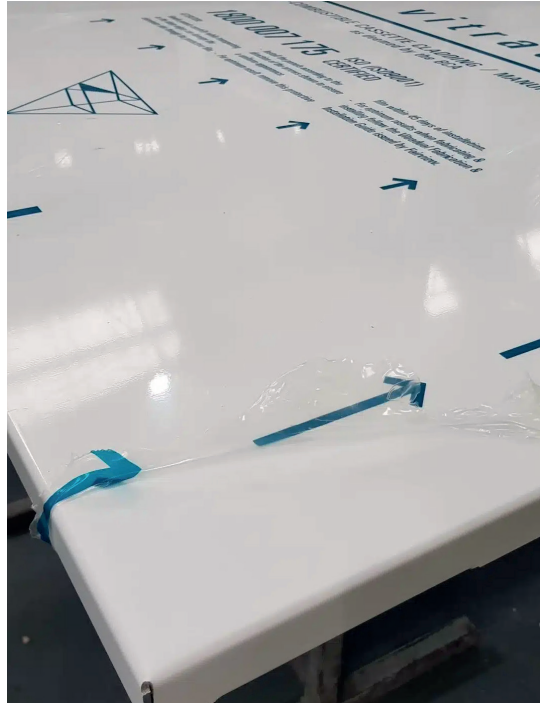

HANDLING

- Panels must be lifted off a pallet/stack rather than being dragged
- Panels must be lifted by 2 people
- Panels must be carried in a vertical plane rather than horizontally
- When unloading from a delivery vehicle, pallets must be unloaded in whole rather than breaking down and removing individual sheets off the vehicle
- Unloading of pallets must be done using a suitable forklift, if a crane is to be used, ensure the wide straps are used (with appropriate protection) to spread the weight and that straps are placed to prevent slipping of the pallet/goods
- Do not remove strapping etc. until pallet has been unloaded from delivery vehicle
- Aluminium panels with protective film must have the film removed within 30 days of installation. The temporary protective film only has a life expectancy of 6 months and should be removed within this time, failure to remove may cause glue to cause issues with the paint surface

TRANSPORTATION

- Panels must be transported under waterproof covers on level pallets
- Panel must be securely strapped to pallets to prevent movement in transportation
- Ensure that straps for load to vehicle are not excessively tight causing damage to sheets – use of strapping corners must be used to distribute the forces

Visit the [website](#) or scan the code to view our storage & handling instructions:



PROTECTIVE FILM

1. Make sure no damage will occur to the panel following removal of protective film
2. Remove protective film within 30 days of installation to avoid glue residuals on panel surface due to weathering
3. Do not apply PVC tapes, polyurethane sealant or silicone sealant onto VitraDual protective film. The plasticiser contained in these materials can penetrate the protective film and cause a gloss change in the coating.
4. Do not apply spray paint or permanent marker to the film as the colour may penetrate the film and affect the panel.

CLEANING

When it comes to cleaning your VitraDual products, only the best will do. That's why we recommend using mineral spirits, organic cleaners or PH-neutral solvents. These products are gentle on your products but tough on dirt and grime, leaving your products looking like new. Plus, they're safe for you and the environment, so you can feel good about using them. So when it's time to give your products a little TLC, reach for one of our recommended cleaning agents and get the job done right.

KEEP YOUR WARRANTY FRESH

Maintaining your VitraDual finish is an important component to maintaining your warranty. Document each time you clean your VitraDual panels. Cleaning frequencies are based on project location and are provided in the warranty.

Warranties are transferable on application - contact enquiries@valcan.co.uk for more information.



PROJECTS

VALCAN | VITRADUAL® SUBFRAME SYSTEM INSTALLED



Bradstowe House, Harrow | London



Flamingo Court, Crampton Street | London



Southdown View | Portsmouth

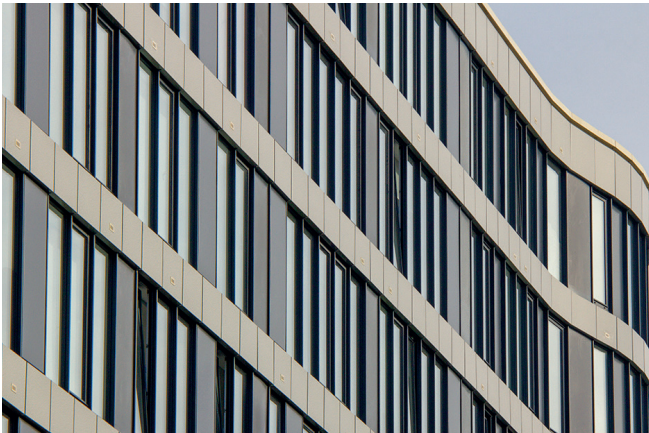

We are proud to have completed numerous projects that feature VitraDual Aluminium Cladding. Our team of experts has years of experience installing and working with this panel solution, ensuring a high-quality finish on every project.



Blenheim Court | Bristol



Piccadilly Point | Manchester



Streamlight Tower | London



If you're interested in seeing the results of some of our previous projects, visit our [website](#) or scan the QR code for more information and in-depth details:



SUSTAINABILITY AT VALCAN: LEADING THE CHARGE FOR A GREENER FUTURE

At Valcan, we don't just see sustainability as a duty to our environment, we see it as a distinctive business strategy and a dynamic opportunity to innovate.

Our dedication extends to constantly discovering creative ways to recycle and reuse materials, starting with our very own cladding panels.

We're particularly thrilled about our initiative of recycling previously installed cladding panels and re-purposing them into vital components of our VitraFix® cladding subframe system.

This strategic approach not only minimises waste but also enables cost-saving in production and contributes significantly to reducing our carbon footprint.

The cycle of sustainability begins with the careful disassembly of the older cladding panels composed of 5000 grade aluminium.

Once segregated, these reusable materials undergo processing and transformation into novel components for VitraFix®. Following this, each component is rigorously tested to meet our stringent quality standards.

Our sustainable methods do more than just helping us honour our commitment to the environment; they equip us to provide our customers with an environmentally friendly choice.

When clients select Valcan, they're assured that



their cladding panels are not just robust and reliable, but they're also contributing to a greener planet with their choice of recycled materials. Our pioneering stance in the cladding industry is a testament to our innovative strategies for waste reduction and our devotion to fostering sustainability.

As we continue to challenge ourselves in exploring new methods of recycling and reusing materials, our focus remains on diminishing our environmental impact and laying the groundwork for a sustainable future.



VitraDual® 2mm or 3mm non-combustible aluminium panel is registered with The International EPD System - Registration number: S-P-04405. En15804 compliant.

Our Vision for a Greener Future:

At Valcan, our goal is to become a greener and more sustainable company by constantly evaluating and improving our operations. We aim to lead the charge in our industry by:

- Continually researching and implementing innovative, eco-friendly manufacturing processes.
- Promoting responsible sourcing of raw materials and engaging with suppliers who share our commitment to sustainability.
- Encouraging our employees to adopt sustainable practices, both at work and in their daily lives.
- Collaborating with industry partners to advocate for better environmental policies and standards.

By taking these steps, we hope to create a positive impact on the environment and inspire others within our industry to follow suit. Together, we can build a more sustainable future for generations to come.

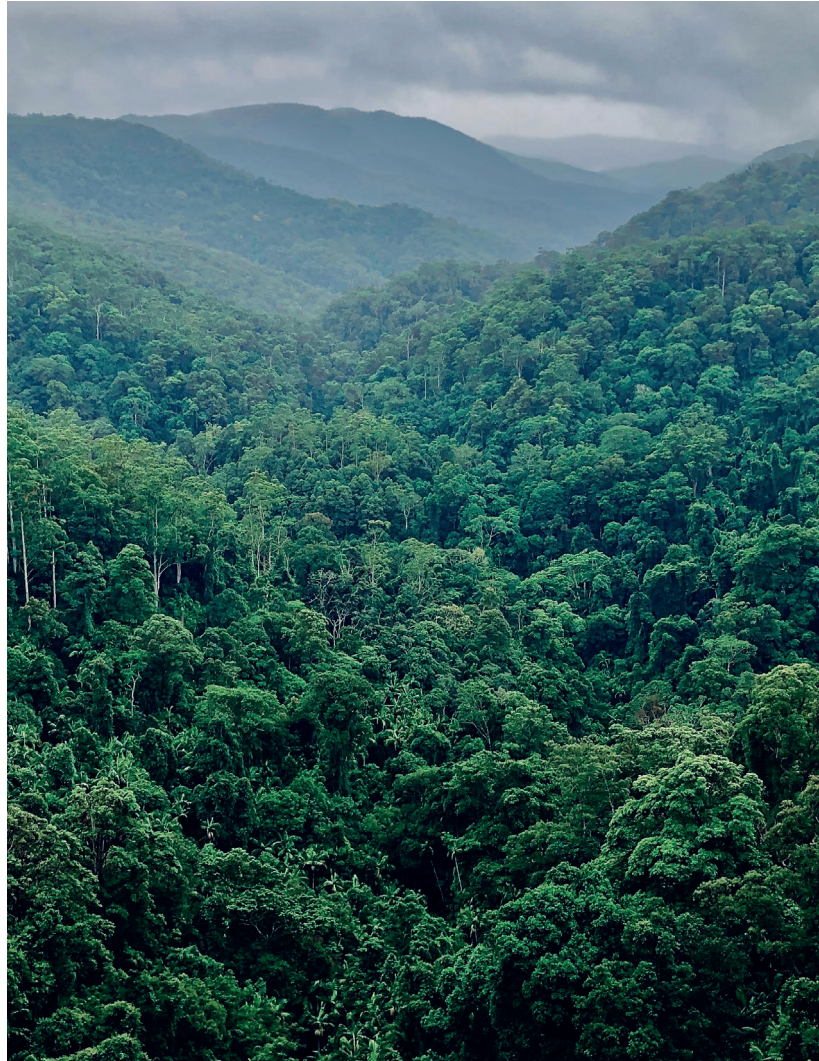

Partnership with Ecologi:

Valcan has joined forces with Ecologi, a forward-thinking organisation that plants trees and supports community projects worldwide. Through this partnership, we are offsetting our carbon emissions, contributing to reforestation efforts, and investing in global sustainability projects.

Recycling Program for Aluminium Panels:

We believe in the power of recycling and have implemented a recycling program for our aluminium panels. Customers can return old or damaged panels to us, and we will recycle the materials, ensuring that resources are utilised efficiently where waste is minimised.



CONTINUING PROFESSIONAL DEVELOPMENT (CPD)



The CPD Standards Office
CPD PROVIDER: 21338
2022-2024
www.cpdstandards.com

Join our free cladding CPD presentations online via or face to face at your premises.

Our popular CPD focuses on fire safety for buildings over 11m high. Lasts for 1 hour including a round of questions and answers at the end.

This provides a fantastic learning opportunity for architects, installers and construction professionals in the UK.

Topics explained are:

- ▲ Introduction To Valcan
- ▲ Rainscreen Cladding Overview - How It Works
- ▲ Fire Regulations - ADB Vol 2 Amendments
- ▲ How These Amendments Affect Your Project
- ▲ How To Comply Following The Ban On Combustible Cladding
- ▲ EN13501-01 Classification Explained
- ▲ The Difference Between A1 / A2 classifications
- ▲ The Golden Thread
- ▲ The Building Safety Act 2022
- ▲ Testing Options
- ▲ Valcan Solutions - Fibre Cement, ACM & Aluminium etc.
- ▲ Case Studies
- ▲ Questions & Answers Session

Book your place



Either [book online](#) or contact the Valcan team who will be happy to help and book you in for a time and p that suits you enquiries@valcan.co.uk



INSTALLATION SUPPORT

We understand the importance of site visits and quality assurance. If needed, we are happy to arrange a site visit to provide on-site guidance and ensure that the installation is progressing smoothly. Alternatively, we are more than willing to review photographs of the installation to offer remote assistance and double-check any crucial details.

Our aim is to make the installation process as straightforward as possible. With our support, guidance, technical assistance, and comprehensive resources, you can trust that our cladding systems are designed for ease of installation. We are dedicated to your success, and we go the extra mile to ensure your project is completed to the highest standards.

The route to compliance of the Golden Thread includes all parties; from the client through to the final resident. It is important that everyone does their part to create a future proof record complying with building regulations as set out in the Approved Document B (ADB). Sequencing of works, inspections, commissioning, environmental hazards and project record keeping is responsibility of the installer/designer/contractor.

INSTALLER TOOLBOX TALKS

In our pursuit of fostering a cultural change in the industry, we stand at the forefront as advocates for implementing Dame Judith Hackitt's Golden Thread Principles. Our aim is to empower clients who choose Valcan products to embrace these principles effectively.

To ensure that our standards remain uncompromised, we kindly request all prospective installers to take part in Toolbox Talks and provide tangible proof of operating a professionally managed business. This encompasses aspects such as accurate pricing, efficient project completion, and the ability to offer a comprehensive package to clients.

Support and Toolbox Talks will be provided on:

- ▶ VitraFix®, VitraDual® & Ceramapanel®
- ▶ Fabrication Techniques
- ▶ Installation Methods
- ▶ General Housekeeping
- ▶ Questions & Answers

To take part in an Installer Toolbox Talk get in touch with us by speaking to your contact directly.

Alternatively, call us on 01278 428 245 or email us at enquiries@valcan.co.uk and we'll get you registered for the training course.





vitradual[®]

Aluminium Cladding Panel

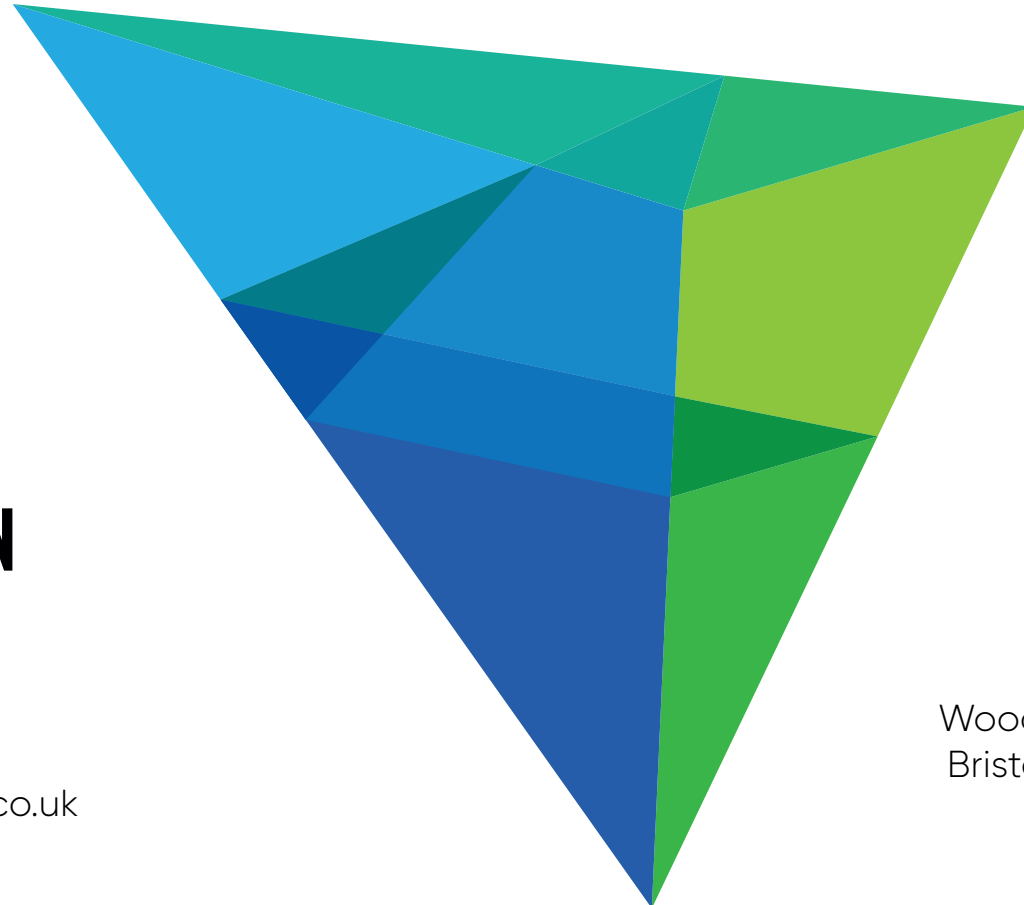

V A L C A N

The Defining Standard

T: +44(0)1278 428 245

E: enquiries@valcan.co.uk

W: www.valcan.co.uk

Dunball House,
Woodlands Court Business Park,
Bristol Rd, Bridgwater, Somerset
TA6 4FJ

